

How To Assemble Your Cherrystone Designs DIY USB Strat Kit

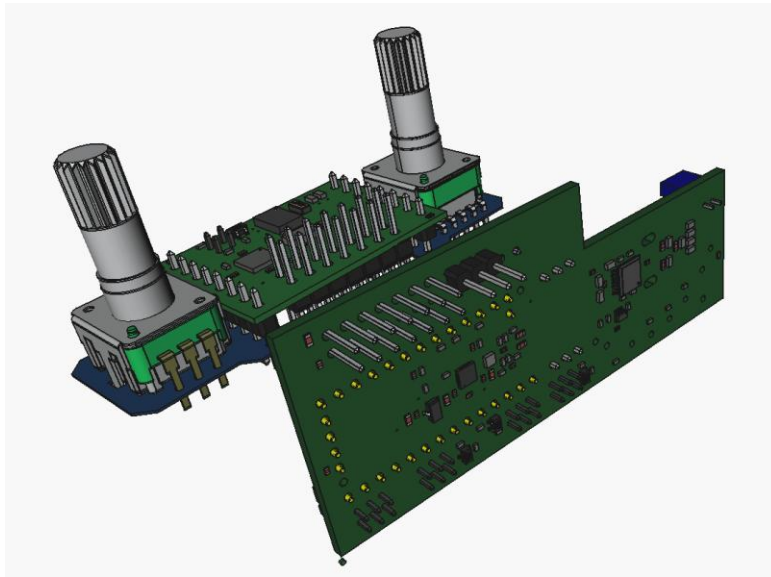

May 11, 2026

The Cherrystone Designs DIY USB Strat kit comes with the following parts:

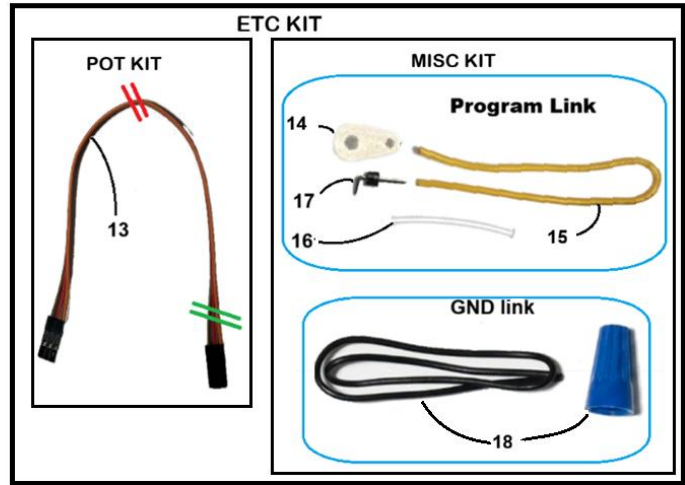
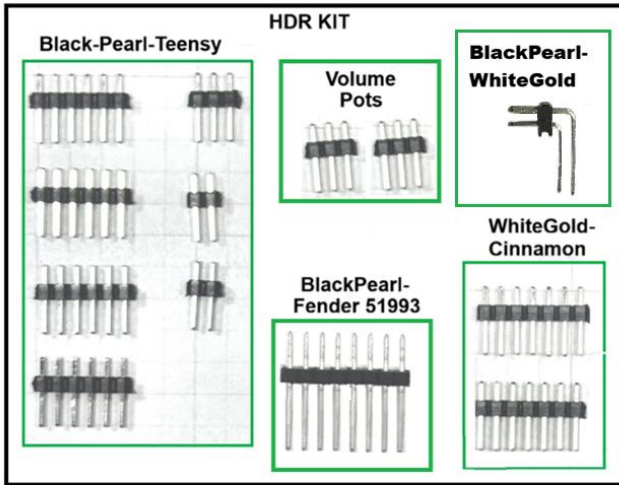
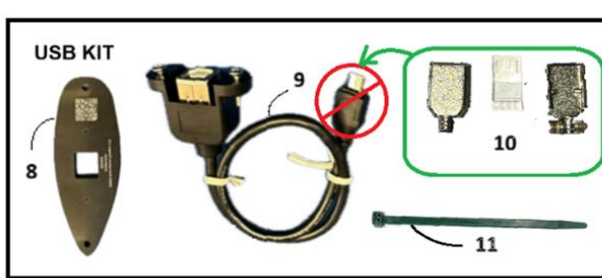
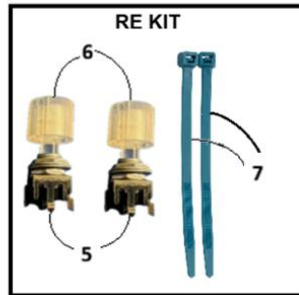
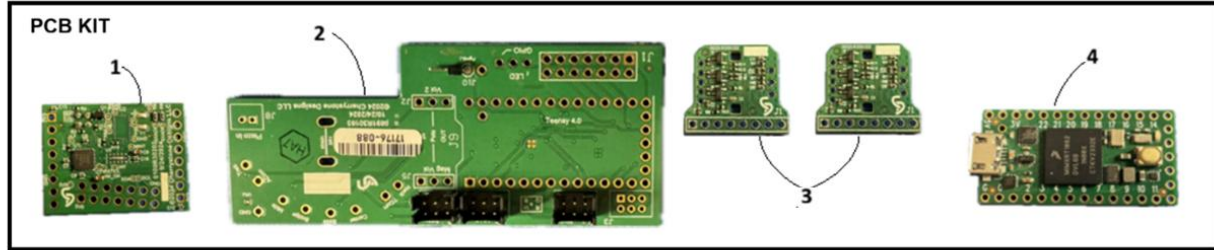

A. PCB Kit

PCB KIT Components

1. Cherrystone Designs WhiteGold_0100R30202-A1
2. Cherrystone Designs BlackPearl_0091R30103-A1
3. Cherrystone Designs Cinnamon_0021R20102-A2 (x2)
4. Pjrc Teensy 4.0

B. Rotary Encoder Kit

RE KIT Components

5. Top Up RGB LED PB Rotary Encoders (2), washers & nuts (4)
6. Top Up Translucent knobs (2)
7. Zip Cable Ties, 4", Teal /cyan (2)

C. USB Kit

USB KIT Components

8. Cherrystone Designs Staccato_0102R10101-USB jack plate
9. Adafruit P937A Panel USB-B F to μ B M cable
10. USB- μ B solder connector, with clamshell
11. Zip Cable Ties, 4 1/2", green

D. Noiseless Pickup Adapter Kit

PUP KIT Components

12. Cherrystone Designs 2c & 4c shielded pickup 5-wire splice kits (3)

E. Potentiometer Adapter Kit

POT KIT Components

13. Adafruit 3-pin 2.54mm x 20cm cable assembly (I/O links to 1 or 2 pots)

F. Misc/Etc Kit

Misc/Etc KIT Components

14. Term Lug Ring #4 Flat (PGM screw terminal under pickguard)
15. Insulated wire, 4", yellow (PGM)
16. Heat-shrink tubing, 1" (PGM)
17. 1x1x0.1" RA pin (PGM)
18. Insulated wire 8", black (GND) & Wire nut (GND)

G. Header Kit

HDR KIT Components

- 1x8x0.1" M-S LONG [BlackPearl-Fender 51993]
- 1x6x0.1" M-S (4) [BlackPearl-Teensy]
- 1x3x0.1" M-S (3) [BlackPearl-Teensy, Volume Pots]
- 1x2x0.1" M-S (2) [BlackPearl-Teensy]
- 1x7x0.1" M-S (2) [Cinnamon-Rotary Encoders]
- 2x7x0.1" M-RA (1) [WhiteGold-Cinnamon]

The PCBs need to be soldered together. For this purpose, various square-pin headers are included.

There are many basic soldering tutorials out there. Here's one:

[iFixit's Soldering 101: Beginners Guide](#)

Be kind. If you find that information valuable, click 'Like' and 'Subscribe'.

[Soldering Accessories, consumable non-durables](#)

DIY USB Strat Kit Connectors

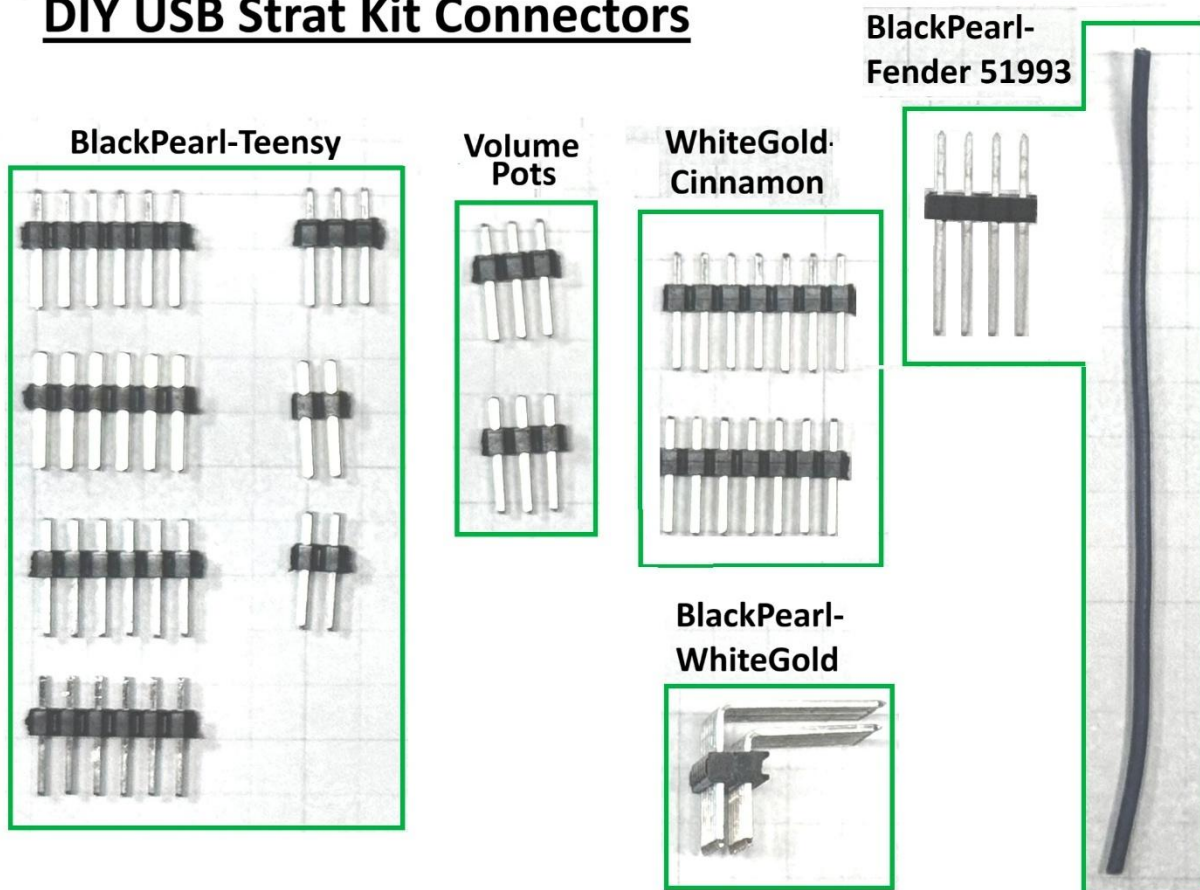

DIY USB Strat Suggested Assembly Sequence

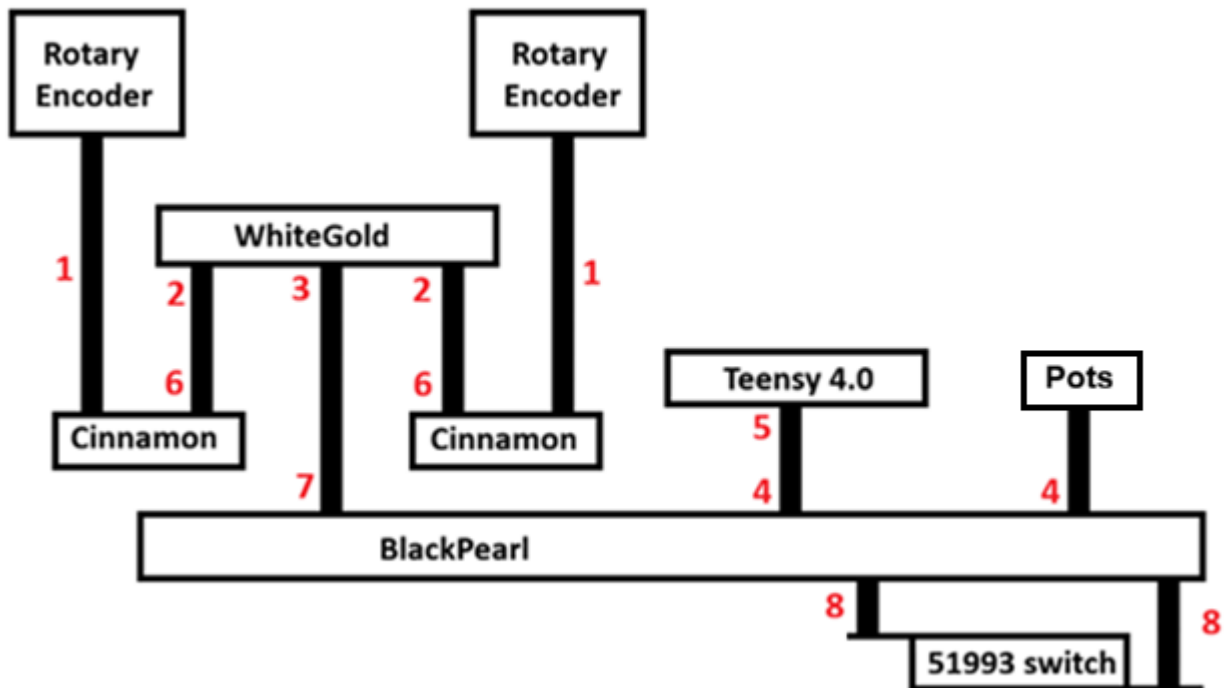

The headers should be soldered together in a specific order, summarized in this drawing:

[Step 1: Solder the Rotary Encoders to the Cinnamon PCBs](#)

[Step 2: Solder the straight headers to the White Gold PCB](#)

[Step 3: Solder the angled dual-row header to the White Gold PCB](#)

[Step 4: Solder the straight headers to the Black Pearl PCB](#)

[Step 5: Solder the Teensy 4.0 to the Black Pearl Straight headers](#)

[Step 6: Solder the Cinnamon PCBs to the White Gold PCB](#)

[Step 7: Solder the White Gold PCB to the Black Pearl PCB](#)

[Step 8: Solder the Long straight pins to 5-way Switch](#)

[Step 9: Install the USB jack plate and USB cable](#)

[Step 10: Install the GROUND wire and Program wire](#)

[Step 11: Install the 4c shielded Pickups \(optional\)](#)

[Step 12: Connect the Potentiometers](#)

Step 1: Solder the Rotary Encoders to the Cinnamon PCB.

1. This is what the end of this step should look like:
2. These are the items you need in addition to your soldering tools:
 - Cinnamon_0021R20102 PCB
 - Top Up (SparkFun COM-15141) Rotary Encoder
 - Soldering Consumables
3. Note that there are two sides to the Cinnamon_0021R20102 PCB:

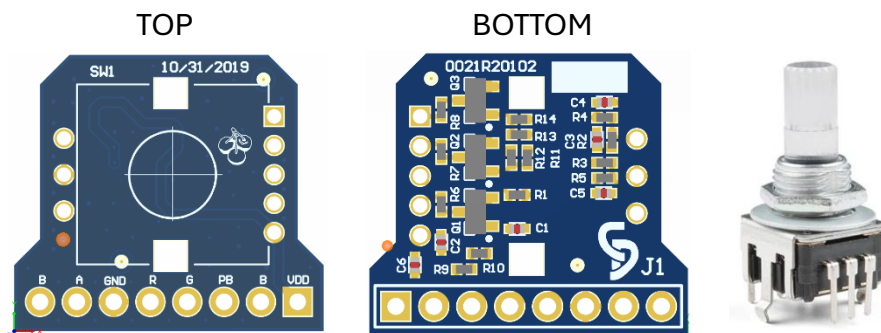
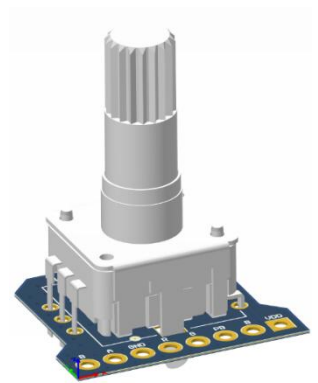

Usually, the top side is the component side, but not here. The top is where the rotary encoder goes. The bottom side is where all the surface mount devices (SMDs) are already attached.

Note that the encoder has 3 pins on one side and 5 on the other. Note that the Cinnamon PCB has a constellation of holes that match those pins. That is a strong clue how to orient the encoder on the PCB. The second clue is the white rectangle silk-screened onto the TOP side. Clue #3: The side where you see the 3 cherries.

Note that there are also 2 large square cutouts to accommodate the encoder's two side tabs. They appear as white rectangles in this rendering. Those tabs are for mechanical reinforcement. There is no metal in the cutouts to solder the tabs to on this PCB, but after soldering the two rows of pins, these tabs should be bent in such a way that they improve the mechanical bond with the PCB, being careful to avoid shorting out R14, C1, or J1.

Follow general soldering advice below for cleaning/fluxing the pads & pins, prepping the soldering tip, & mind your air quality while soldering the encoder to the PCB.

A Vise works well to hold your work as you solder the pins.

Don't forget to flush-cut the excess length of the soldered pins, reflow the solder, then clean and recoat your soldering iron with fresh solder before turning it off.

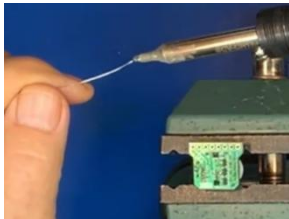
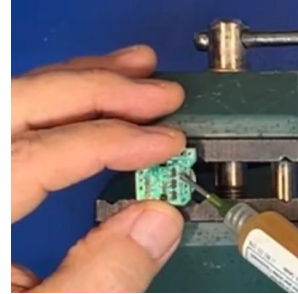

With the worry of a hot soldering iron off our mind, you can now tidy up the PCB by spraying it with 99.9% pure anhydrous Isopropyl Alcohol (IPA) and scrubbing it gently with a soft bristle circuit board brush (often marketed as toothbrushes) dedicated to this purpose. Flux residue, while often benign, can attract dust, absorb moisture, and cause tiny conductive "whiskers" to grow that can short circuits. Best practice is to remove it and make your work pretty as well as reliable.

Grok sage advice:

- Work in a well-ventilated area, wear gloves/eye protection.
- Spray or pour IPA generously over the area (keep it wet – don't let it dry halfway).
- Scrub gently with a soft toothbrush, acid brush, or ESD brush.
- Keep flushing with fresh IPA while scrubbing so dissolved flux is rinsed away.
- Wipe or blow dry with compressed air / lint-free cloth.
- Repeat if needed.

Bonus tips:

- Clean the PCB as soon as possible after soldering — fresh residue is much easier to remove.
- No-clean fluxes get harder to clean the longer they sit and the more they polymerize.
- If you're doing hand-soldering prototypes or guitar pedals, cleaning with IPA makes boards look professional and prevents weird failures years later.



Step 2: Solder the straight headers to the White Gold PCB.

1. This is what the end of this step should look like:

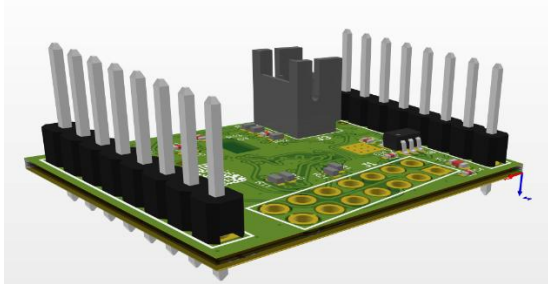

2. These are the items you need in addition to your soldering tools:

- WhiteGold_0100R30202-An (The suffix n denotes irrelevant assembly variants)
- Qty: 2, Header_1x8x0.1"MS (MS: Male, Straight; single row of 8 square pins)
- Alcohol (IPA), **99.9%**
- Q-Tip for applying alcohol.

3. Note that the pin headers have 3 parts:

- A short tail
- A plastic spacer
- A longer tail



4. Prep the WhiteGold for soldering the 8-pin headers.



Insert the short tail end into the WhiteGold PCB, on the side that is marked with a white silkscreen rectangle and QR code.

You'll need some way to hold the pins straight, hands-free, while the solder is molten and solidifying. Alligator clips, bench vise, solderless breadboards, and anti-static foam work well, but are not a complete list.

5. Clean all metal contacts to be soldered with IPA alcohol. 99.9% is preferred. This includes both sides of the solder pads of J1, J5, and J6 as well as the short tails of the 8-pin headers.

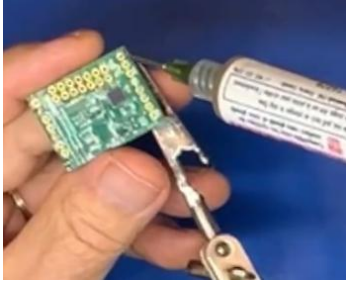

After the pins are clean, before soldering, apply a small amount of flux to each pad. This will remove any existing oxide coating and prevent oxidation when the metal is heated, allowing for a more reliable solder joint.

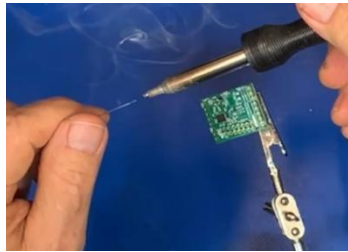
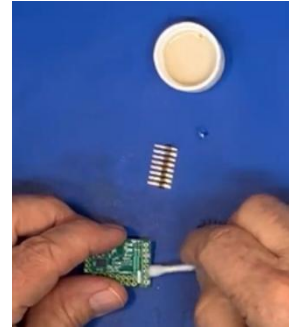

6. As you turn on your soldering iron, immediately flow some solder onto the tip to prevent it from oxidizing, and to increase the heat transfer from the tip to the pad and connector pin. It is recommended that you use fume control to avoid breathing or contaminating your workspace with unhealthy fumes.

7. Four surfaces must touch for solder magic to happen:

- The soldering iron tip
- The PCB pad
- The header pin
- A string of solder

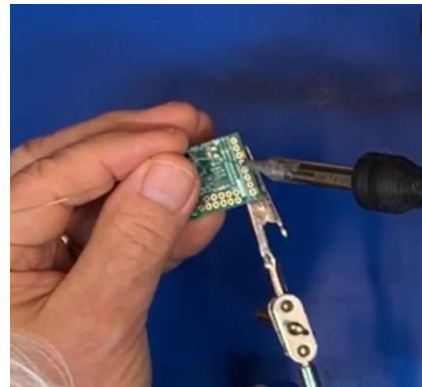

8. **TIP:** Avoid flowing too much or too little solder. Coat every surface with a minimal amount. Remove the heat source and keep the joint stable until the solder resolidifies. Excess solder can be removed using [solder braid](#). Manual vacuums have their own drawbacks: splatter & static.

CAUTION: Movement may cause an unreliable “cold-solder joint” which you may remedy by reflowing the existing solder while preventing movement. But BEFORE continuing...

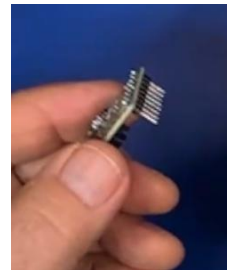

9. **ONLY SOLDER ONE PIN.** Before soldering the remaining 7, verify that the pins are aligned straight up & down. If not, heat up that joint and straighten it. When you're satisfied that the connector is straight, you can complete the job. A crooked connector is much easier to adjust when there is only one solder joint involved.

When one connector is soldered, repeat the process with the other.

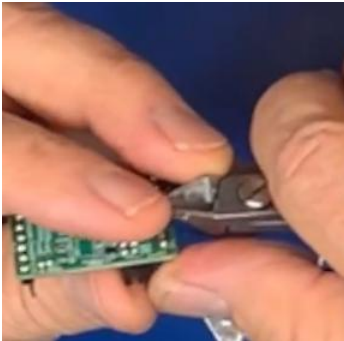
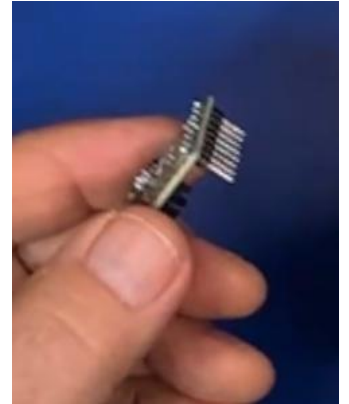

10. The WhiteGold PCB will eventually be installed on the bottom of the pickguard between the tone control holes. In most cases, the control cavity will be surrounded by a conductive shield which may look like sheets of metal, or conductive paint, but the back of the pickguard will likely have a conductive film. To avoid shorting out the circuitry of WhiteGold, it's necessary to prevent contact. This is why it is important to clip off the excess

leads that have just been soldered. Flush cutters are better than diagonal cutters for this task. They are designed to leave a smooth, burr-free surface.



11. Control where the tiny terminal cuttings end up. Don't allow them to hide on your PCB where they can short something out. If you lose track of them (there are 8 per connector), find the escapees and dispose of them.

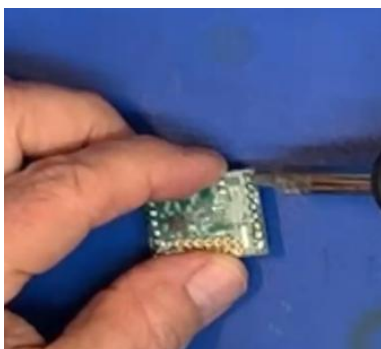

12. After clipping the excess pin length, reflow the solder so that its profile resembles a lazy conic tent and that the pad is completely covered.

The IPC J-STD-001 Standard for Soldering shows the difference between a good solder joint and several not-so-good joints. Google it if you don't know what it should look like and filter the search results for Images.

Or spend the \$300+ to obtain the [latest revision](#).

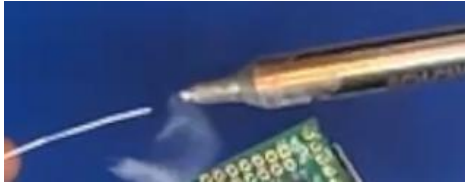

13. If you take a break, make sure that you clean the tip of your soldering iron and re-tin it with fresh solder before turning it off. I often set a timer to turn off my iron after a short session so I don't leave it on unattended.

Step 3: Solder the angled dual-row header to the White Gold PCB.

1. With WhiteGold J5 and J6 soldered, the next step is attaching J1.

These are the items you need in addition to your soldering tools:

- WhiteGold_0100R30202-An (The suffix n denotes irrelevant assembly variants)
- Qty: 1, Header_2x7x0.1”MRA (MRA: Male, Right-angle; two rows, 7 pins each)
- Alcohol (IPA), **99.9%**
- Q-Tip for applying alcohol.

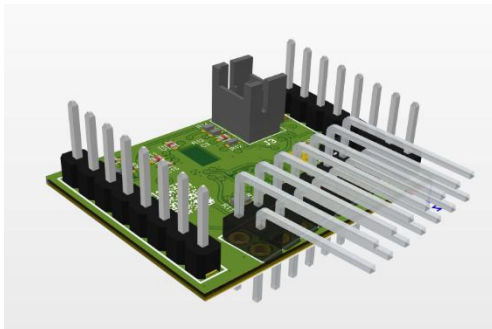

J1 is the bent double-row connector in your kit.

This is what it will look like when it is soldered. Note: It is also inserted in the side of the PCB with the white rectangular silk-screen box (the same as the 8-pin straight male headers J5 & J6).

As before, solder **ONLY** a single pin. Before soldering the remaining 13, verify that the rectangular plastic spacer is flush against the PCB (i.e., there is no gap).

Complete the soldering as before. Remember to use flux, pre-wet your tip with solder, set the position before continuing, clip the excess leads, reflow the solder, etc., and store your iron tip with fresh solder.

2. When finished soldering, clean and recoat the tip with a fresh amount of solder and turn off the heat to prevent the tip from degrading.

Step 4: Solder the straight headers to the Black Pearl PCB

This is what it will look like at the end of this step:

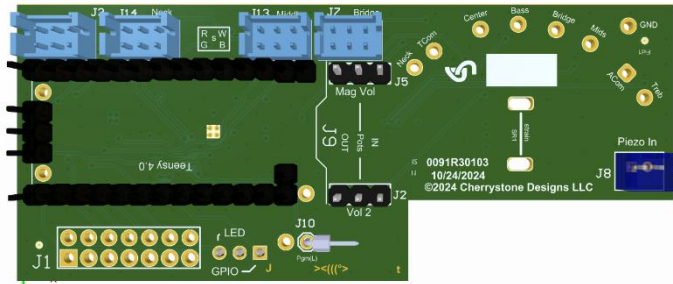

Pay careful attention here:

If you bought your Teensy 4.0 from one of the many vendors, they sometimes include header pins. These are rows of vertical pins held together with molded plastic, so they maintain the 0.1” pin-to-pin spacing. The ones they include are inadequate for this project because BlackPearl uses some extra pins that aren’t in the “normal” DIP (Dual-Inline-Package) constellation. These specified connections are all necessary. If you follow these directions and use the included or recommended connectors, you won’t likely have any perplexing surprises.

Soldering the Teensy header connectors will involve joining sections at a time. This step may be edited in the future but for now, it is what it is.

1. In addition to your soldering tools and accessories, you’ll need:

- BlackPearl_0091R30103-An (The suffix n denotes irrelevant assembly variants)
- The following included headers are single rows of straight male pins with 0.1” pin-to-pin spacing held in place by molded plastic, used as circuit board connectors:
 - Two 2-pin headers
 - Three 3-pin headers
 - Four 6-pin headers

Note: This procedure results in a nearly permanent connection between Teensy and BlackPearl. Although it’s possible to detach them, it isn’t easy with DIY tools. If you plan to detach the Teensy in the future for any reason, you can substitute low-profile Samtec socket strip assemblies and compatible pins. Be aware that they’re more expensive and fragile and can be purchased at Digi-key and other electronic component distributors:

- 2-pin pairs: [SL-102-T-19](#) (Female) and [BBL-102-T-E](#) (Male)
- 3-pin pair: [SL-103-T-19](#) (Female) and [BBL-103-T-E](#) (Male)
- 6-pin pairs: [SL-106-T-19](#) (Female) and [BBL-106-T-E](#) (Male)

Obviously, if you go that route, the sockets should be soldered to the top side of the Black Pearl and the compatible male pins soldered to the bottom of the Teensy.

Note that there are two sides to the BlackPearl_0100R30103 PCB:

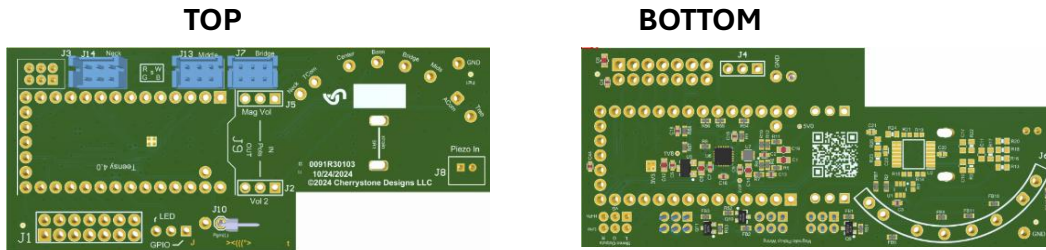

Teensy 4.0 Will be attached to the TOP side, where there are white silk screen lines bounding the right and left sides of the J9 pad constellation. The bent lines are the side where the Teensy USB connector is located. Do NOT place it on the BOTTOM, covering the Surface Mount Devices (SMDs). **That would not be good.**

We'll first attach the header pins to the BlackPearl, then attach the Teensy to the header pins.

HINT: When you place the connectors as shown in each diagram, only solder one or two pins at the most. When everything fits together, you can commit to those placements. If they don't fit quite right, you'll need to reflow the solder so you can adjust the pin orientation, so they are completely vertical and not leaning askew.

You also may need to file a small amount of plastic from adjacent pin sets as they may have residual burrs from where they were separated. Small collisions prevent optimal seating. Remove only offending burrs and not structural plastic.

Header map:

The headers will be inserted according to this placement map. The first number is the row count. In every case here, there is only one row of pins. The second number is the pin count in each row.

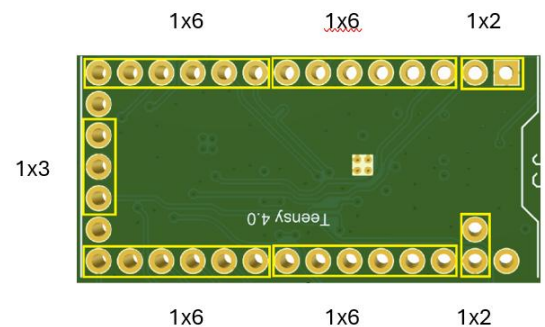

We will be adding several row header connectors to J9. The first two will be the 2-pin headers. Insert the short end of the pin in the top-side holes with the plastic molding touching the surface of the BlackPearl PCB. Insert them as shown below. Note the plastic spacer is on the top side of the PCB, not the bottom side.

Step 4-1: Solder the two included 2-pin headers in the locations shown. Solder **ONLY** one pin on each.

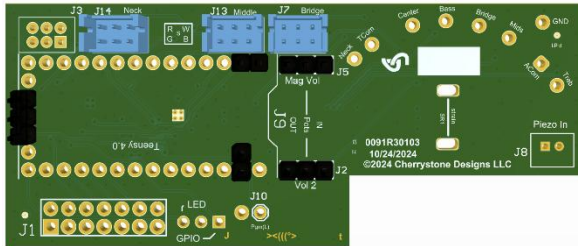
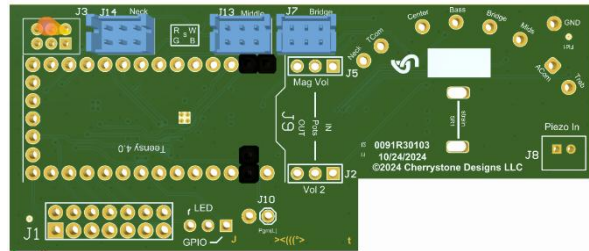

Step 4-2: Next, place the 3-pin header in the locations shown, and solder **ONLY** one pin.

In the case of the J2 & J5 3-pin headers, adjust the orientation to be straight up & down when the solder is still molten. When you are satisfied that condition is met, solder the other two pins and reflow the solder on the first.

When you are satisfied that condition is met, solder the other two pins and reflow the solder on the first.

Step 4-3: Solder two of the four included 6-pin headers in the locations shown.

The order of Step 4-3 and 4-4 is not important, but before soldering, check if there are any plastic burrs on the ends that might prevent the 6-pin headers from aligning. If so, file them gently and reseal until they play well together. Then **ONLY** solder one pin each to hold them in place.

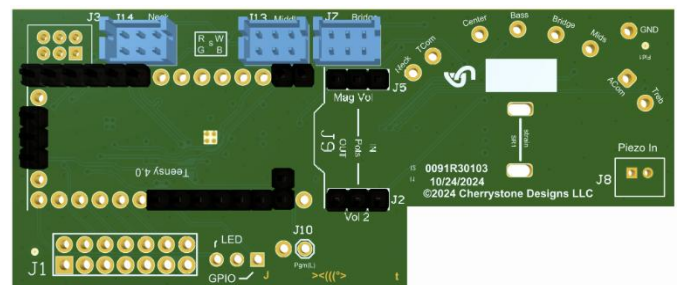

Step 4-4: Solder the remaining 6-pin headers in the locations shown.

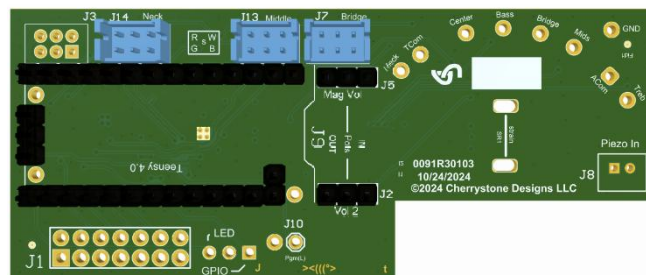

Step 5: Solder the Teensy 4.0 to the Black Pearl Straight headers

1. This is what the end of this step should look like:

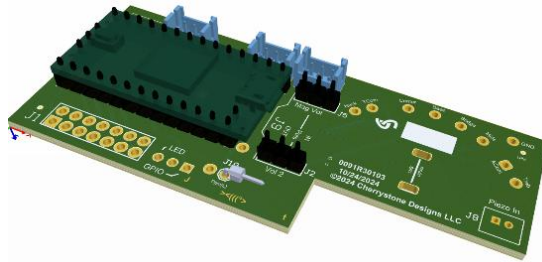

2. In addition to your soldering tools and accessories, you'll need:

- BlackPearl_0091R30103-An (The suffix n denotes irrelevant assembly variants)
- Teensy 4.0 Microcontroller Unit (MCU)

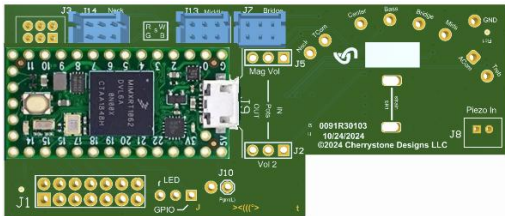

Insert the Teensy 4.0 on the vertical pins.

Note the orientation: USB connector on the right and the square microcontroller is on top.

When it is certain that all the pins go through all the pad holes and that there are no significant gaps between the header spacers and each circuit board, you can solder each pin to each pad on each PCB, then clip excess leads & reflow solder as before.

Step 6: Solder the Cinnamon PCBs to the White Gold PCB.

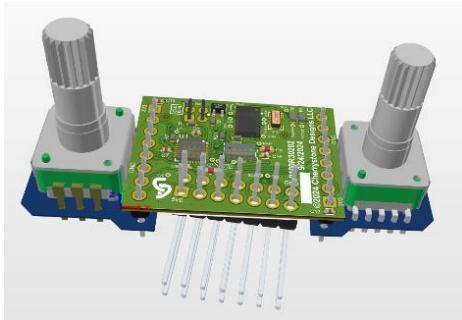

This step requires a pickguard to establish the depth of the solder joints.

1. Slide the Cinnamon PCBs with the rotary encoders mounted in Step 1 over the straight 8-pin headers soldered to the WhiteGold PCB as shown. **Do not solder yet.**
2. Attach the rotary encoders to the pickguard tone control holes using the included washers and nuts [**order**: nut, washer, pickguard, washer, nut] making allowance for the thickness of your specific pickguard. The WhiteGold PCB will then be captive but can slide freely along the length of the pins.

This is a **critical** part: You want WhiteGold to be as close to the pickguard as possible without touching it. Even if you've removed the shielding, you might someday move this Kit to a different Stratocaster that still has its shield intact. **A short circuit would ruin your day.** So, you want to place something between the pickguard and the WhiteGold to establish a uniform clearance while the soldering is occurring, something like thin cardboard or a similar bespoke temporary spacer that can be removed easily.

With that spacer in place, solder one of the middle pins of each 8-pin connector. Check for fit. If all is well, solder the remaining pins, then clip excess leads & reflow solder as before.

Step 7: Solder the White Gold PCB to the Black Pearl PCB.

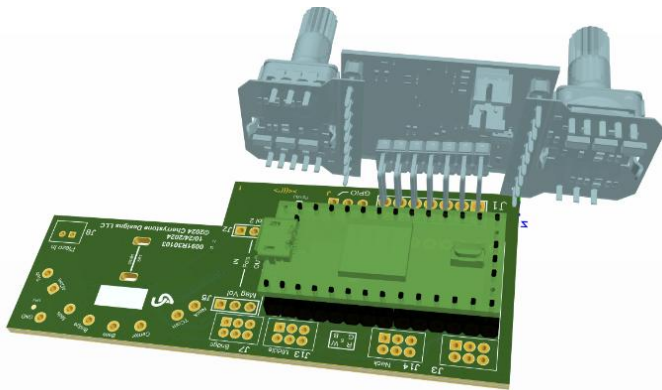

This is a step that requires tailoring to your Stratocaster control cavity.

The location of your WhiteGold PCB and Fender 51993 5-way switch are determined by the rather rigid locations of the Stratocaster pickguard.

The objective here is to align the semi-circular holes of BlackPearl's J6 connector near the solder tabs of Fender's 51993 5-way switch. To do this, the solder connection between WhiteGold and BlackPearl needs to be a custom fit. The 6° angular offset built-in to WhiteGold establishes the proper direction of BlackPearl but the excess length of the 2x7 right-angle header square-pins must be trimmed or it will collide with the control cavity wall.

- Solder only one pin.
- Trim most of the excess, leaving enough length to make slight adjustments.
- When the assembled kit fits in the control cavity while attached to the pickguard and the pickguard holes align with the screw holes, you can solder the remaining pins, trim the excess, and reflow the solder.

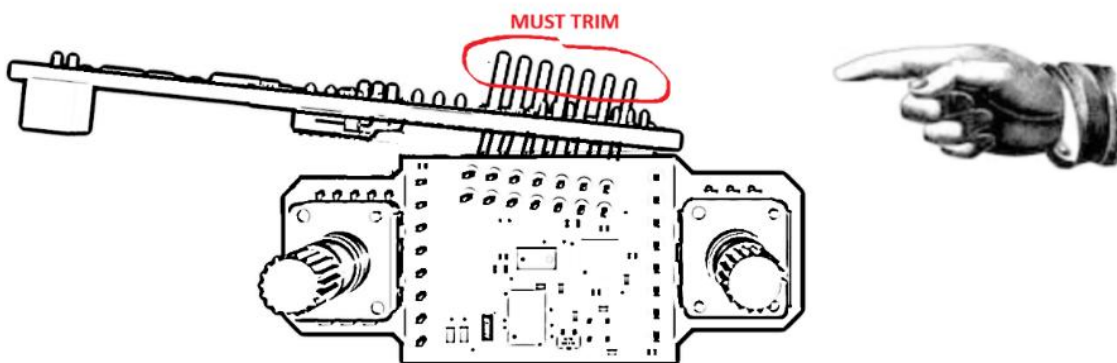

Step 8: Solder the Long straight pins to 5-way Switch

Solder the long pins to BlackPearl's arcing connector J6 as shown, which will align with the solder tabs of Fender's 51993 5-way switch.

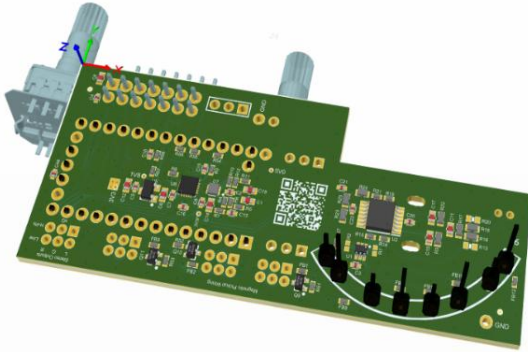

The images show the header pins having two different lengths. An executive decision was made to include *only* long ones for these 8 connections between the 5-way blade switch and the BlackPearl PCB.

You need to separate them with a sharp pair of cutters. You can insulate the longer ones with insulation that you remove from the ground and program bell wire included in the kit (Step 10).

Before soldering the 51993 5-way switch to these pins, insert the included green zip tie as shown, but don't tie it off yet (It will be more difficult to insert after the switch is attached). It will secure the cable from stressing the USB connector during installation.

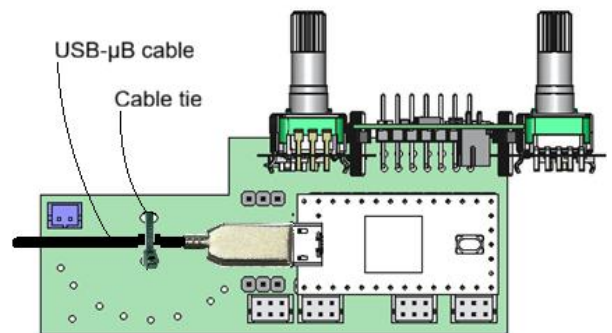

Notice the orangish-red circuit board embedded in Fender's [Electroswitch/Oak Grigsby]



51993 5-way switch. The closer solder tabs carry analog pickup signals to and from the BlackPearl PCB. Analog signals don't like exposure, so keeping those connections short minimizes potential problems. The static DC signals on the other side of the orange phenolic resin circuit board don't matter as much, though both are protected from stray EMI on the PCB.

Notice also: If your 51993 switch is installed backwards, *the conductor pins could short out* and you'll be calling to tell me your KIT doesn't work. Let's avoid that and try to match the picture. In either case, the belt AND suspenders approach is to cover any exposed metal with insulation borrowed from your DIY bench supply of bell-wire, or heat-shrink tubing.

Step 9: Install the USB jackplate and USB cable.

The included **Adafruit Industries 937** Panel Mount USB-B female to Micro-B Male Cable mates to the Cherrystone Designs' Staccato USB jack plate 'panel', but the Micro-B Male connector is too fat to fit through the narrow tunnel the factory drilled between the jack plate and control cavities. That tunnel didn't need to be any bigger because old school guitar wires didn't come with fat connectors. Soldering them was something assembly technicians took care of.

The simple solution is to drill a bigger hole. Actually **No!** 'Been there, 'Done that! In spite of my meticulous angle calculations and jig-making, I managed to drill through the back of a Strat.

It's much simpler to cut the micro-B male connector off the cable end, insert it through the existing tunnel, then solder on a new micro-B male connector (included in your kit). No actual Strat mods needed!



A useful video tutorial can be found here:

[How to Solder USB C, Micro, Mini, and A Connectors for Custom Keyboard Cables](#)

Be kind. If you find that information valuable, click 'Like' and 'Subscribe'.

- Cut the microUSB (the *SMALLER* connector) off leaving as much of the cable length as you need to reach the USB connector on Teensy and still have enough service length to move the pickguard around.
- Carefully remove enough of the cable jacket to expose the four colored internal wires without scoring their insulation.
- You can see four solder pads on the end of that micro-B connector. You need to strip *just enough* insulation from each internal wire to cover the connector pad (i.e., not much).

Pin	Name	Wire Color	Description
1	V _{BUS}	Red	+5V
2	D-	White	Data-
3	D+	Green	Data+
4	GND	Black	Signal Ground



Prep each individual wire for soldering:

1. Expose the end of an individual wire, tin it with a small amount of fresh solder.
2. Repeat for the remaining wires.
3. Flow a small amount of solder on each pad of the connector to improve heat transfer. Remove any shorts with solder braid.
4. Solder one wire. Note the wire color association with the solder pad (above).
5. Repeat for the remaining wires.
6. *Optional:* Flow a measured amount of RTV silicone sealant from any local hardware store between the wires to strengthen the physical connection.
7. Install the included clamps covering the new USB μ B connector and bend the clamps on the mating shell to secure the wire from movement that would affect the tiny solder joints.

Step 11: Install the GROUND wire and Program wire.

The circuit board ground should be connected to the guitar strings. Typically, that's done at the tremolo bar spring claw, but your hardtail doesn't have one. [Seymour Duncan's forum](#) has some ideas.

Rather than soldering the BlackPearl to that ground wire, I recommend using two wires:

1. One connected to the spring claw or metal bridge that grounds the guitar strings.
2. The other soldered to the GND pad near the **Mids** pad of the **J6** 51992 5-way switch connector.
3. It can be two ends of the same wire, but if you cut it in half at a practical mid-point and connect them with the included twist-on wire nut, it will make servicing easier.

Make sure there is no bare wire is exposed after the wire nut is secured.



The Teensy 4.0 includes a small button that allows you to “[recovery from bad code](#). Pressing the button puts Teensy into programming mode.”

(Search website for “Program Pushbutton / Pin”)

That button will be buried inside your Strat. Pushing the button shorts a Teensy pin to system GND.

We can short the same node to GND by extending that connection to one of the screws holding down the pickguard. Simply run a wire from J10 on the left to the solder tab on the right and locate the solder tab under one of the pickguard screws. To press the virtual button, short the screw to your grounded strings.

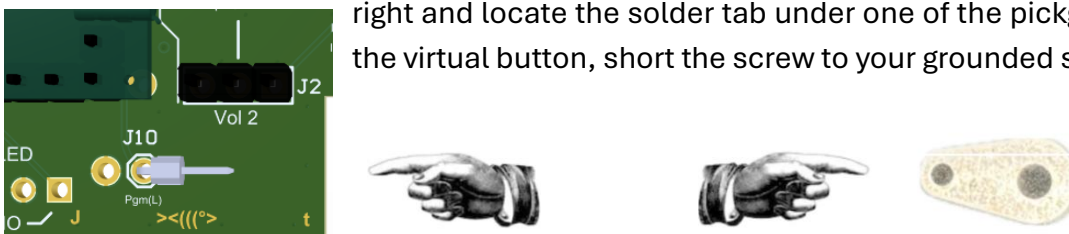

Solder one end of the 4” yellow PGM wire to J10 and reinforce with heat shrink tubing (It’s a more robust connection than simply soldering the wire to the pad). Solder the other end to the #4 Terminal lug ring. The larger hole will contact one of the screws holding down the pickguard, preferably near the strings, but that’s your choice.

Step 12a: Install the 4c shielded Pickups (optional)

Cherrystone Designs does not include any pickups in the DIY kit. That’s a personal choice.

Pickups that are constructed of two wound coils with 4-conductor shielded cable are your best options. Check the manufacturer's page to be sure.



They have many to choose from. If yours includes “**4c (4-conductor) Shielded**” cables, our kit will give it superior performance by allowing you freedom to match your pickup configuration to the tones you select with our controls. You can

find those in Seymour Duncan’s Noiseless Strat online storefront. Look for the **‘OUTPUT / Cable: spec: ‘4c Shielded’**.

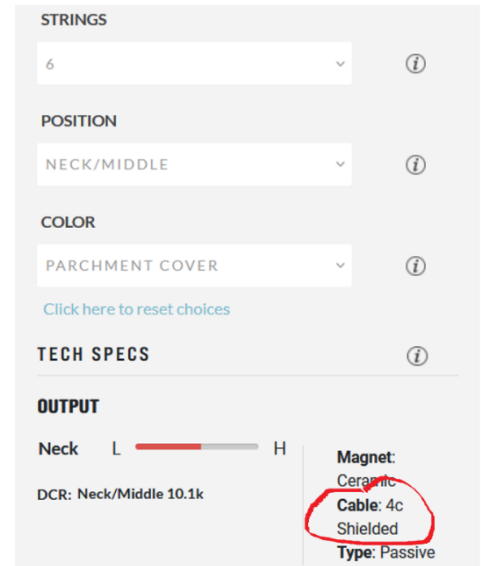

The screenshot shows a configuration interface with the following sections:

- STRINGS:** A dropdown menu set to '6'.
- POSITION:** A dropdown menu set to 'NECK/MIDDLE'.
- COLOR:** A dropdown menu set to 'PARCHMENT COVER'.
- TECH SPECS:** A section with an information icon.
- OUTPUT:** A section containing:
 - A 'Neck' label and a slider between 'L' and 'H'.
 - A 'DCR: Neck/Middle 10.1k' label.
 - A 'Magnet: Ceramic' label.
 - A 'Cable: 4c Shielded' label, which is circled in red.
 - A 'Type: Passive' label.

In old school electric guitars, you had to follow some convoluted medusa spaghetti diagram showing you where each wire goes. With 4-conductor pickups, the complexity doubles. But we make it very easy (unless you’re color blind).

NOTE: Seymour Duncan and DiMarzio have different color codes. It’s important that you specify which adapters you want included in your kit. You’ll need any combination of three, though the first two are best. Fender currently only provides two wires which does not allow us the ability to improve their characteristics. The options are:

1. Seymour Duncan, any position
2. DiMarzio, any position
3. Fender Noiseless, any position, or
4. Fender Single-coil, bridge, middle, or neck positions.

We have specific adapters and instructions for each. You simply need to match the colors.

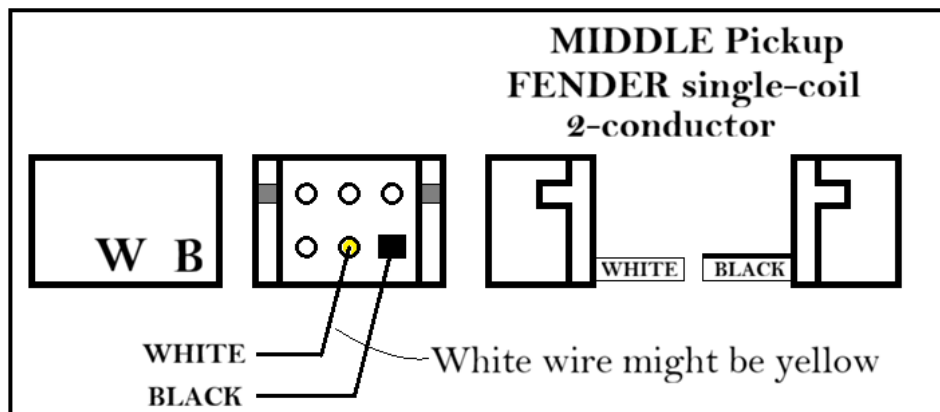
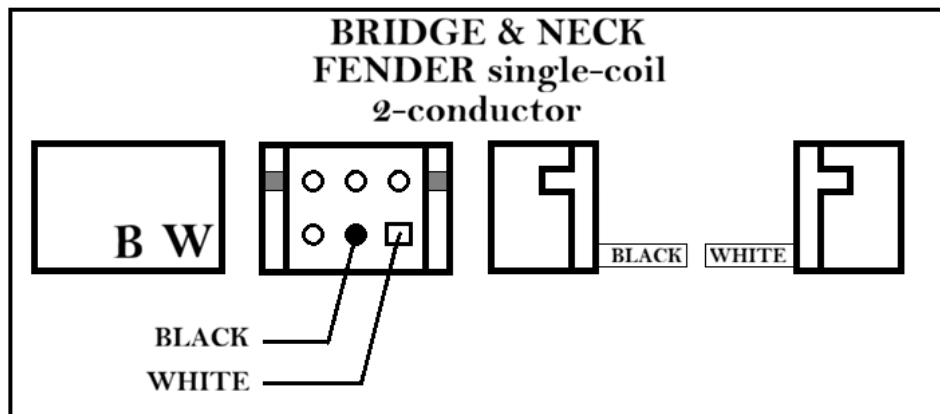
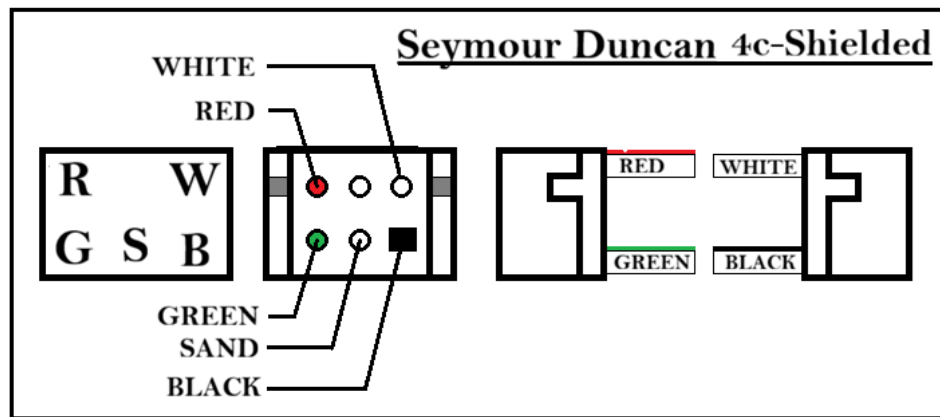
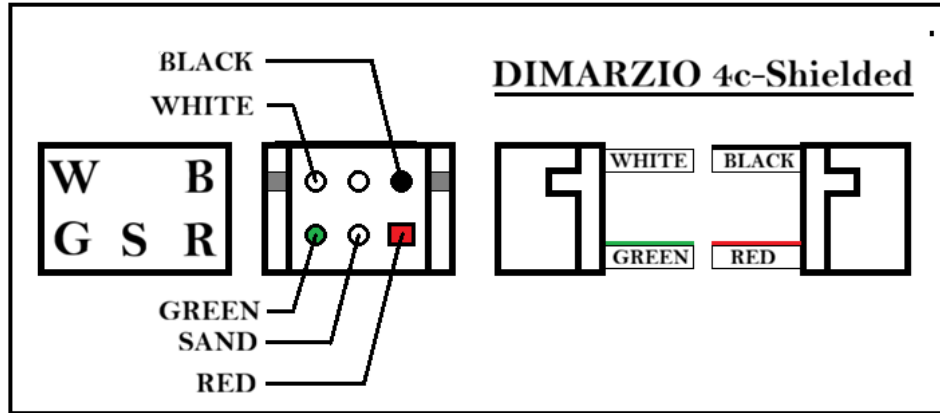

Splicing Adapters to '4c-shielded' noiseless pickups

Here's a **simplified, step-by-step** version of the instructions for installing **Noiseless Strat pickups** (the 4-conductor shielded type with Black, White, Red, Green wires + bare drain) into your **BlackPearl** guitar using the provided **splicing adapter**. This setup makes wiring plug-and-play while maintaining hum-canceling in every position (thanks to our special modification of the re-purposed 5-way switch).

Quick Overview

- These **4c** pickups have **4 colored wires** (Black, White, Red, Green) inside a shielded cable, plus a **bare drain wire** for shielding/ground.
- The splicing adapter has **4 colored leads** (pre-wired into keyed plugs for easy connection) plus a **sand-gray** lead specifically for the bare drain wire.
- Goal: Match colors directly, splice securely, shield properly, then plug in.
- In the case of the **2-conductor** pickups, there will only be two colors: Black & White
Fender uses yellow wires in the middle pickup position—instead of the standard white—to indicate that the pickup is **Reverse-Wound/Reverse-Polarity (RWRP)**. This design, combined with the middle pickup, creates a hum-canceling effect when both the neck and middle or bridge and middle pickups are active.

Step 1: Prepare & Splice the Wires (for each pickup)

You'll splice the pickup's 4 colored wires + drain to the matching colors on the adapter (plus sand-gray for drain).

Tools needed: Wire strippers ([Ideal 45-125](#) recommended for safety), hobby knife (alternative), solder, soldering iron, solder paste (flux), heat-shrink tubing (small for individual joints + larger for overall shielding), aluminum foil.

How to splice (repeat for each wire pair):

1. Strip ~5mm (0.2") of insulation from both the pickup wire and the matching adapter wire.
 - Use the Ideal 45-125 stripper: Start with larger openings and work down to avoid nicking the strands.
 - If you're daring, Use an X-Acto knife: Gently roll/score the insulation, bend the wire, cut around most of it, then pull off the remaining insulation.
2. Twist the stranded wires tightly (prevents stray strands from shorting).

3. Apply solder paste (flux), then tin both ends with molten solder (coat them).
4. Slide heat-shrink tubing onto the longer wire first (before joining!).
5. Bend both tinned ends into tight "U" shapes.
6. Hook the U's together, crimp gently to hold.
7. Solder the joint solidly.
8. Slide the heat-shrink over the joint and shrink it with heat (match, lighter or heat gun) to insulate the bare wire joint.

Color matching — Simply connect same-to-same:

- Black (pickup) → Black (adapter)
- White → White
- Red → Red
- Green → Green

Special: Drain wire

- The bare (exposed) drain wire from the pickup cable connects to the **sand-gray** lead on the adapter.
- This helps maintain overall shielding.

Step 2: Extra Shielding (Recommended for Best Noise Performance)

The linked/soldered wires can pick up interference — shield them like this:

1. Slide a **larger** piece of heat-shrink tubing over the entire pickup cable (past the splices).
2. Tightly wrap the bundle of soldered colored wires with aluminum foil (for extra shielding).
3. Wrap the exposed wire of the **sand-gray + drain** connection around the foil.
4. Slide the large heat-shrink over everything.
5. Shrink it securely.

Step 3: Final Connections

- Your adapter leads arrive pre-inserted into [Hirose 2x3x2mm keyed housings](#).
- Plug them in:
 - **Bridge** pickup adapter → **J7**
 - **Middle** pickup adapter → **J13**
 - **Neck** pickup adapter → **J14**

That's it! No need to reverse polarity or mess with special swaps — the adapter handles the correct phase/polarity for noiseless operation in the in-between switch positions 2 & 4.

Tips:

- Before soldering the pickups, measure & record the resistance of each coil. That will help validate your assembly and that it provides the intended benefit.
- Work one pickup at a time to avoid confusion.
- Test continuity after each splice (multimeter) to ensure no opens or shorts.
- Double-check plugs are fully seated.
- If hum persists, re-check drain/shielding connections — grounding is key.

This upgrade gives you the quiet, vintage-ish Strat tone Fender single-coil pickups are famous for, yet noiseless (hum-cancelling) in the bridge, middle, and neck positions that are normally troubling. Rock on! 🎸

Step 12b: Install other 4-conductor pickups to BlackPearl (another option)

Each pickup coil has a **Start** (S) and a **Finish** (F). One coil is designated **North** (N) and the other **South** (S). **NS**: North-Start; **NF**: North-Finish; **SS**: South-Start; **SF**: South-Finish.

It is critical to make the correct connection between the pickup and the BlackPearl circuit board. As I mentioned, we provide color-matched wire adapters with mating connectors that can only fit one way for each brand of pickup.

Simply splice the adapter's wires to the pickup's matching colors, red to red, green to green, black to black, and white to white. Don't worry about start, finish, north or south.

Did I mention that Gibson also offers 2-coil 4c pickups, with **yet another** color code? They don't appear to offer any in the single-coil size, so they might fit your S body and pickguard if its routed for HSH or HSS. You're on your own there, but this chart can help you sort out the wire color swizzle.

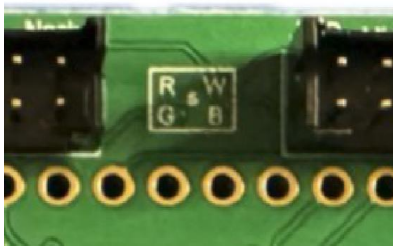

We've standardized on the Seymour Duncan wire colors (on the PCB decal) but can provide DiMarzio, and Gibson adapter sets on request. We have plans to remedy this in due time.

If you are in a hurry, you can mismatch the colors of your DiMarzio or Gibson pickup referring to this correction table:

	Duncan	DMarzio	Gibson
NS	BLACK	RED	RED
NF	WHITE	BLACK	WHITE
SF	RED	WHITE	GREEN
SS	GREEN	GREEN	BLACK

Step 12C: Install old school 2-wire pickups to BlackPearl (the other option)

The middle pickup is physically wired the same as the neck and bridge pickups, but to reduce hum in positions 2 and 4 of the 5-way switch, reverse its polarity:

For the BRIDGE and NECK single-coil pickups

1. Connect white to "White".
2. Connect black to "Black".

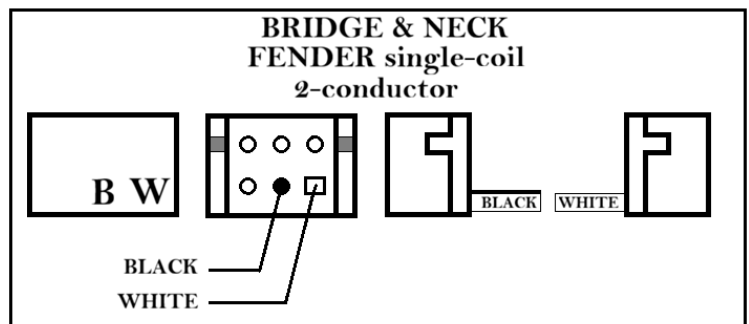

For the MIDDLE single-coil pickup:

1. Connect black to "Black".
2. Connect yellow to "White".

Step 13: Connect the Potentiometers

The Pot Kit comes in a variety of colors so it's necessary to know the pinout of the potentiometer connectors as well as the potentiometer leads.

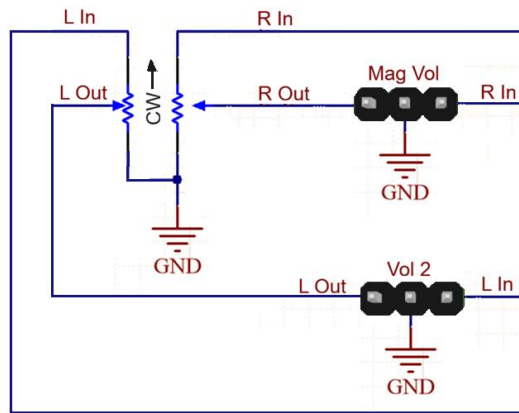
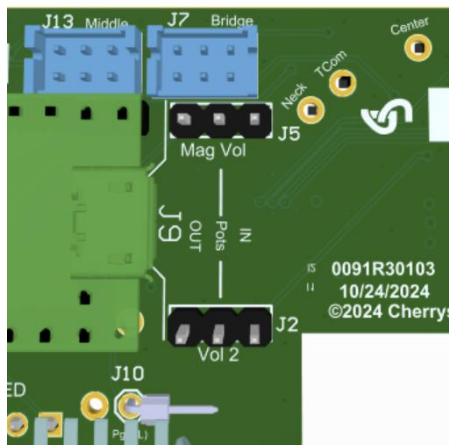
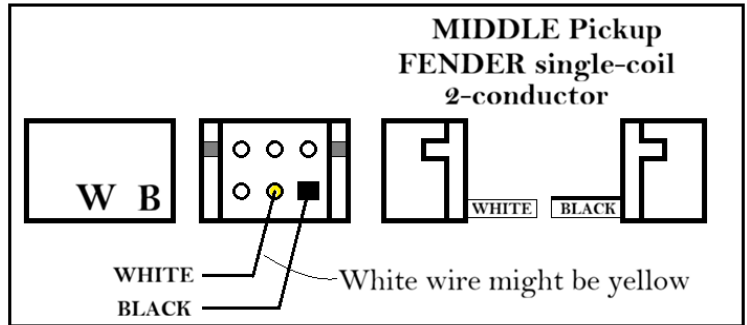

Rotate the pot fully clockwise. The outer solder tab that is shorted to the center tab is the input and should connect to the right pin of J5 or J2 "IN" on the PCB silk screen. The other outer tab is ground and should connect to the center pin of J2 or J5. That leaves the center tab of the pots to be assigned (soldered) to the left pins of J2 and J5 respectively, "OUT" on the PCB. The upper set of three pins controls the conventional magnetic pickup selection and is assigned to the CODEC's right channel.

The lower set of three pins are the left channel of the CODEC (the neck pickup by default).

Soldering Accessories, consumable non-durables

- Alcohol, **99.9%**, Bottle
- Alcohol, **99.9%**, spray, and soft brush
- No Clean Paste Flux, syringe
- Q-Tips for applying alcohol.
- Kester Lead-Free solder

